

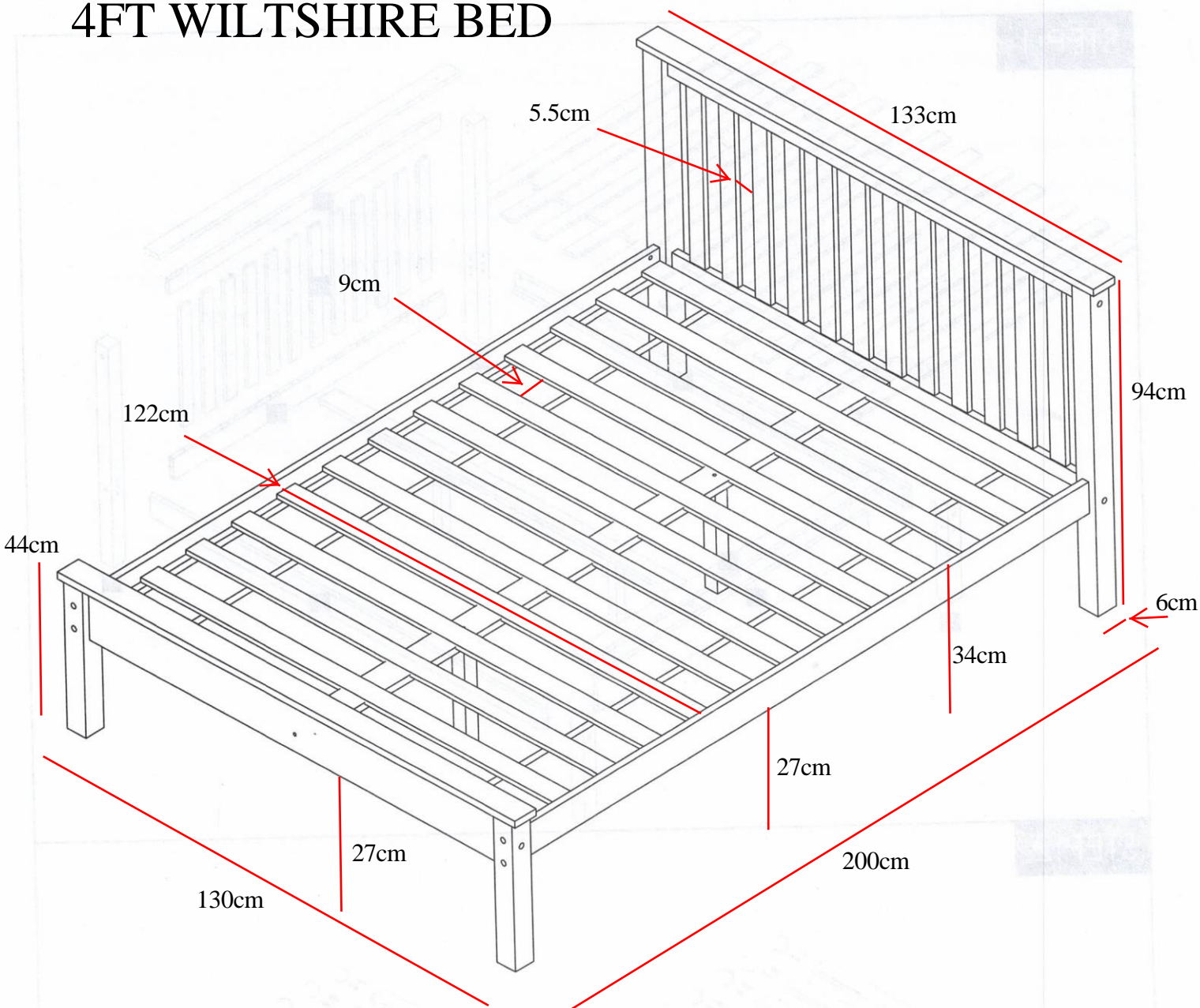









4FT WILTSHIRE BED

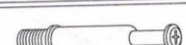

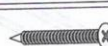

A		M6*90	14
B			14
C		Φ8*30	62
D		1510	6
E			6
F		Φ7*50	4
G		4*30	26
H		Φ15	14
J		Φ12	2
K		4 mm	1

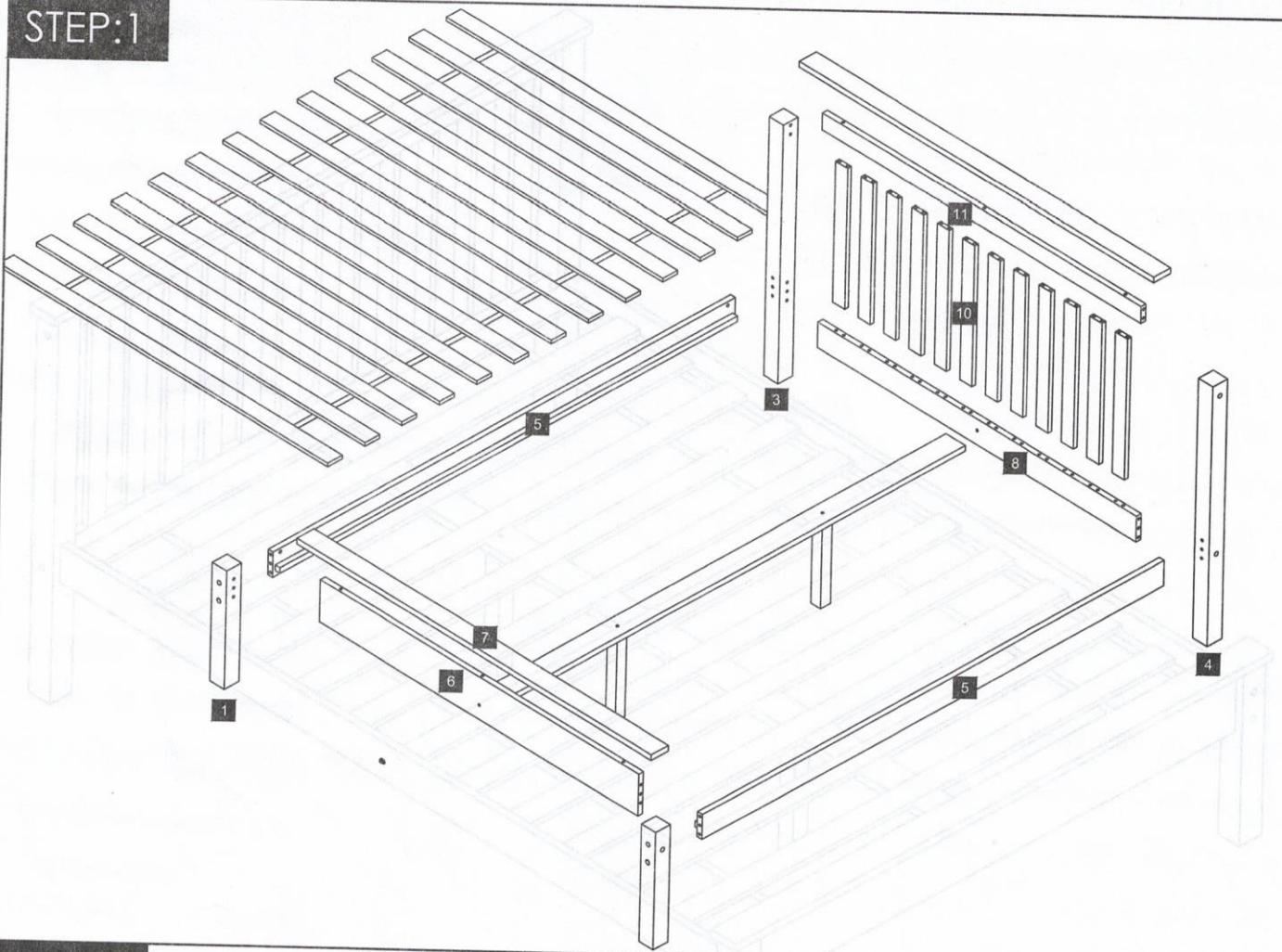
STEP:1

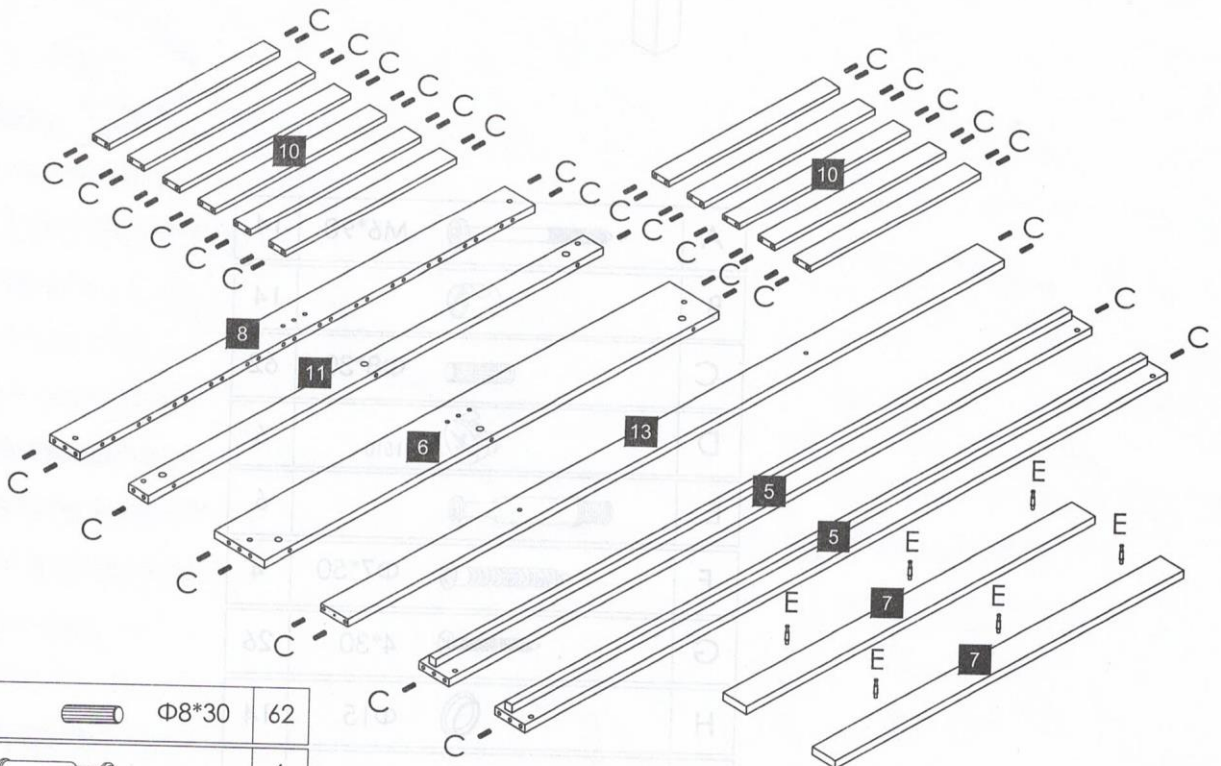

STEP:2

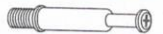

C		Φ8*30	62
E			6

STEP:3

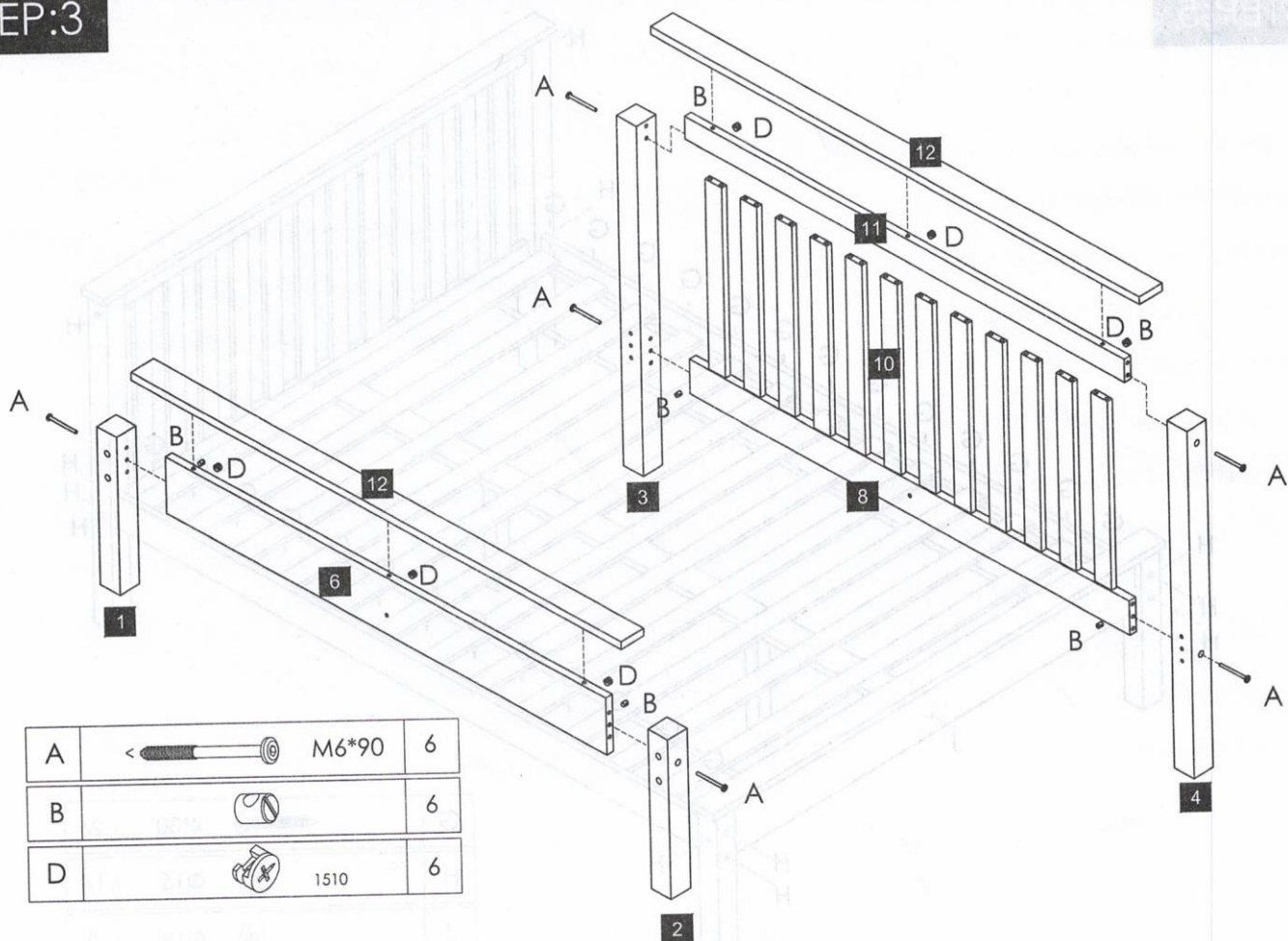

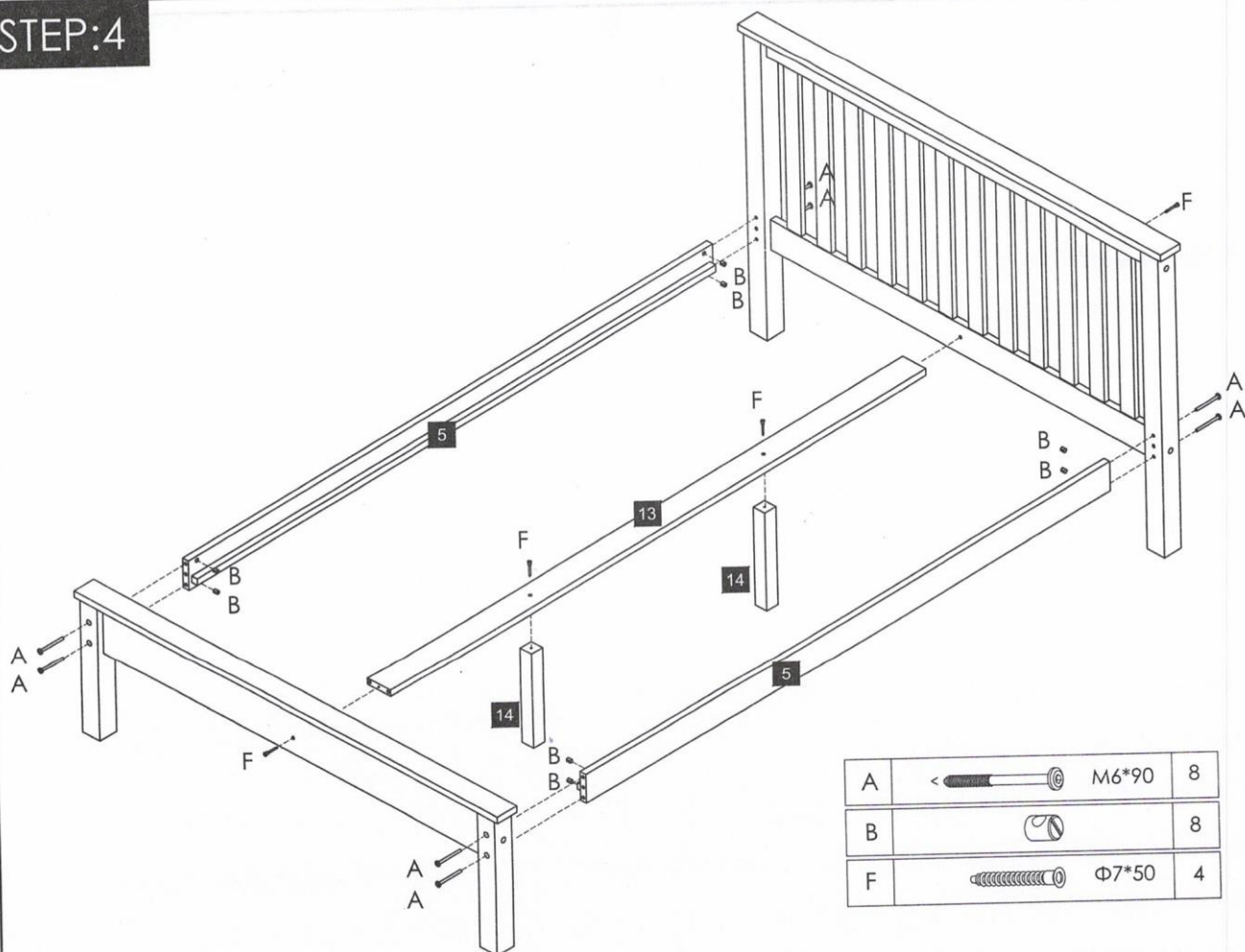

STEP:4

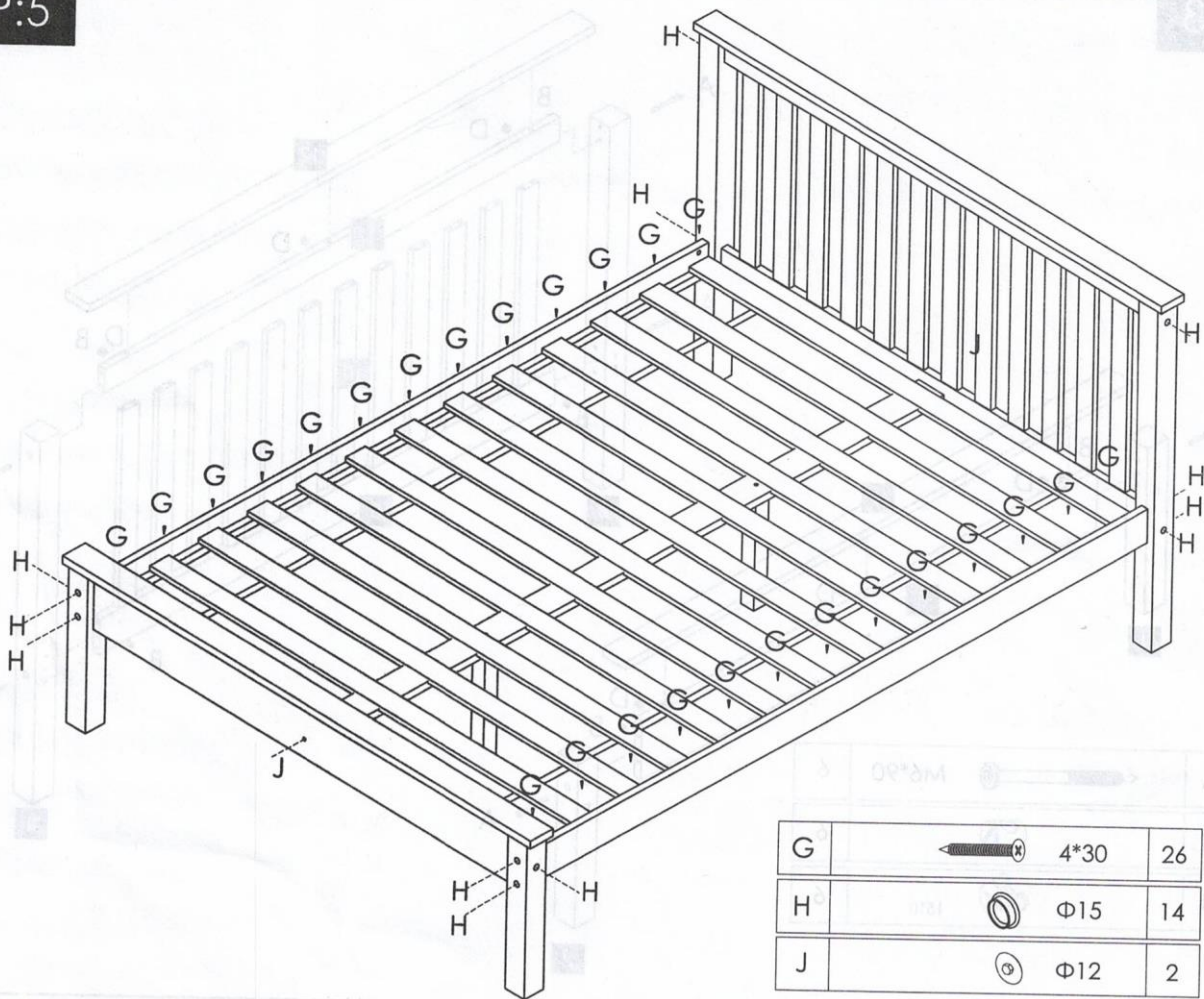

STEP:5



G		4*30	26
H		Φ15	14
J		Φ12	2

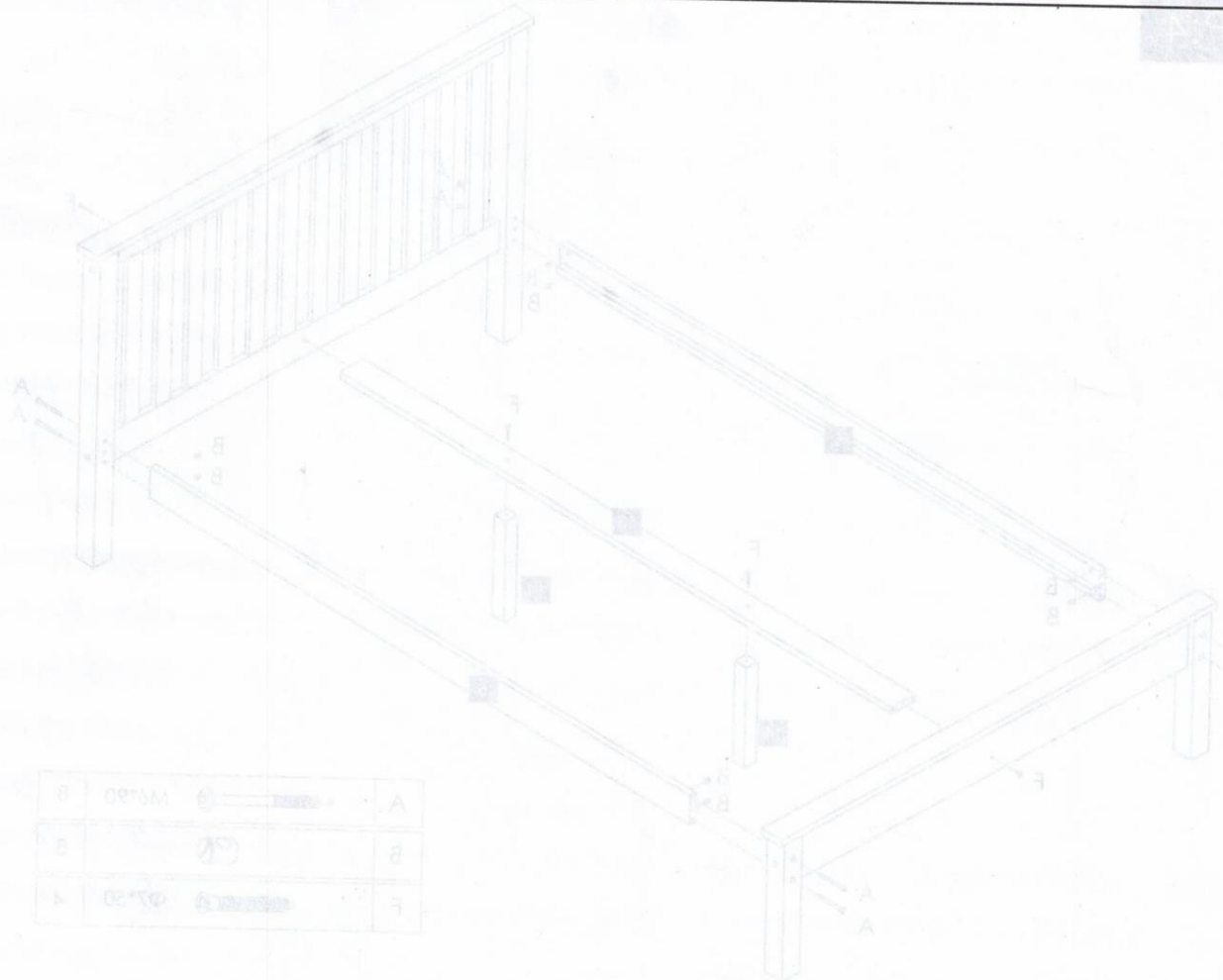

B		4*30	A
B		Φ15	B
A		Φ12	F