

4FT DEVON BED

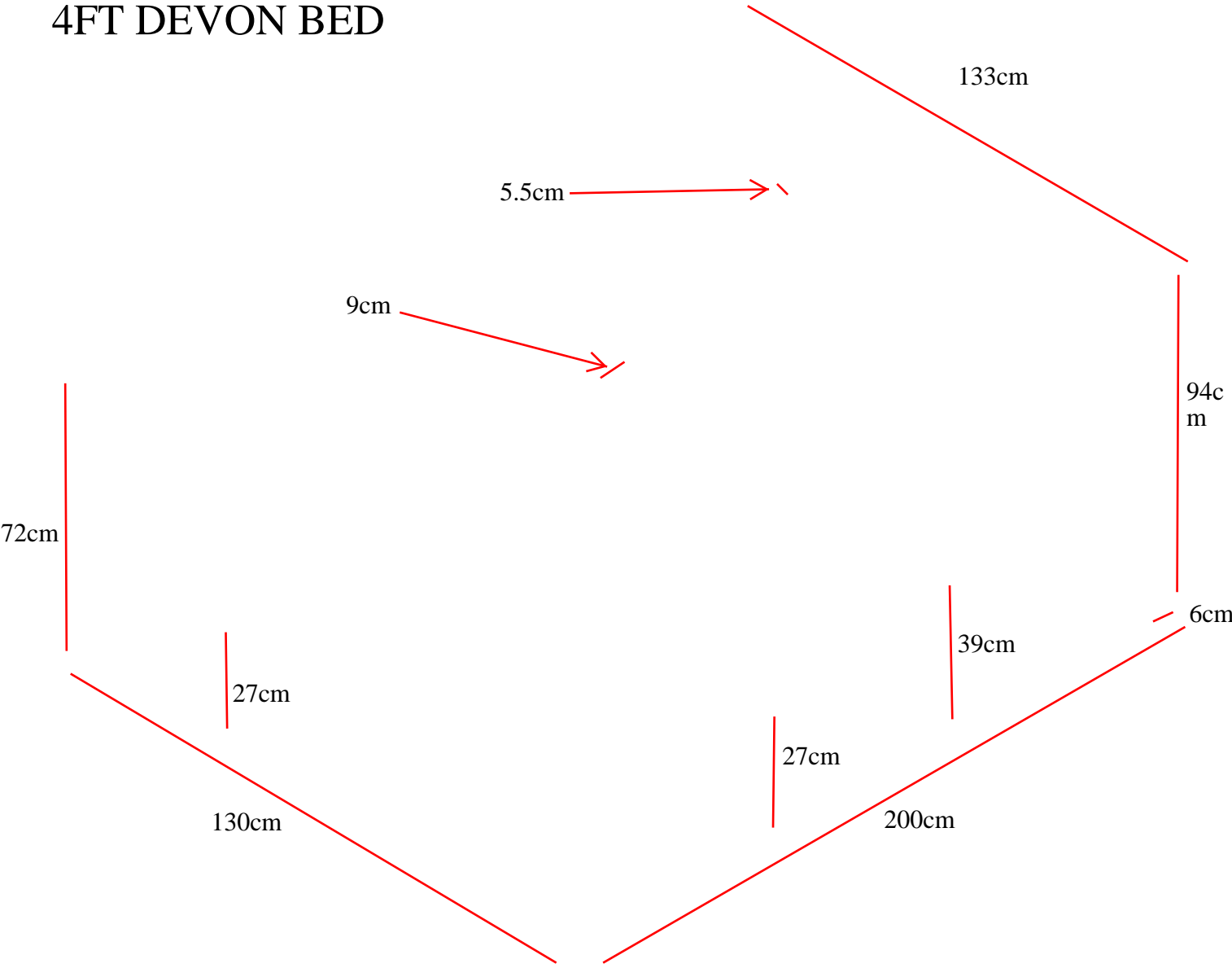

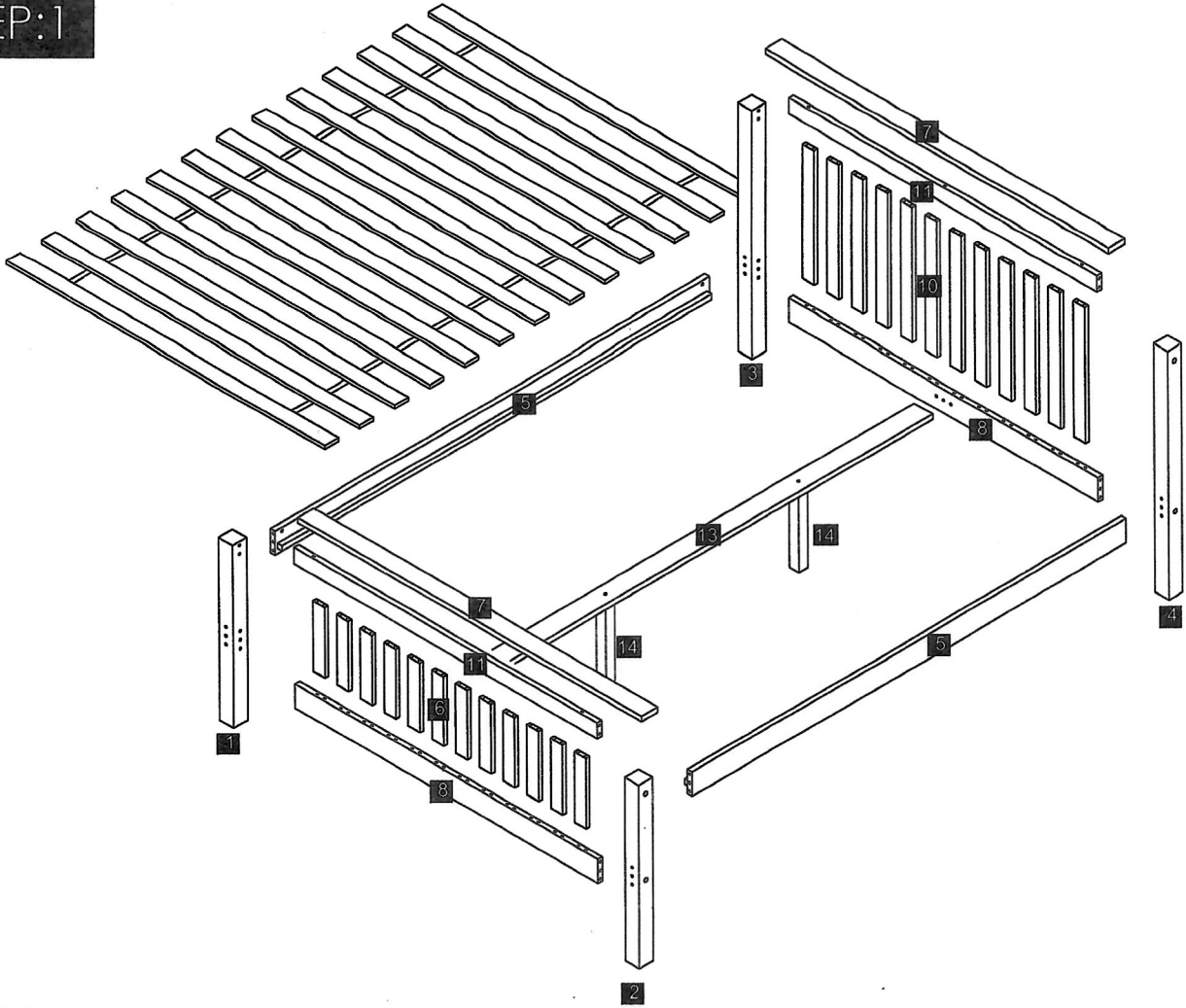

STEP:1

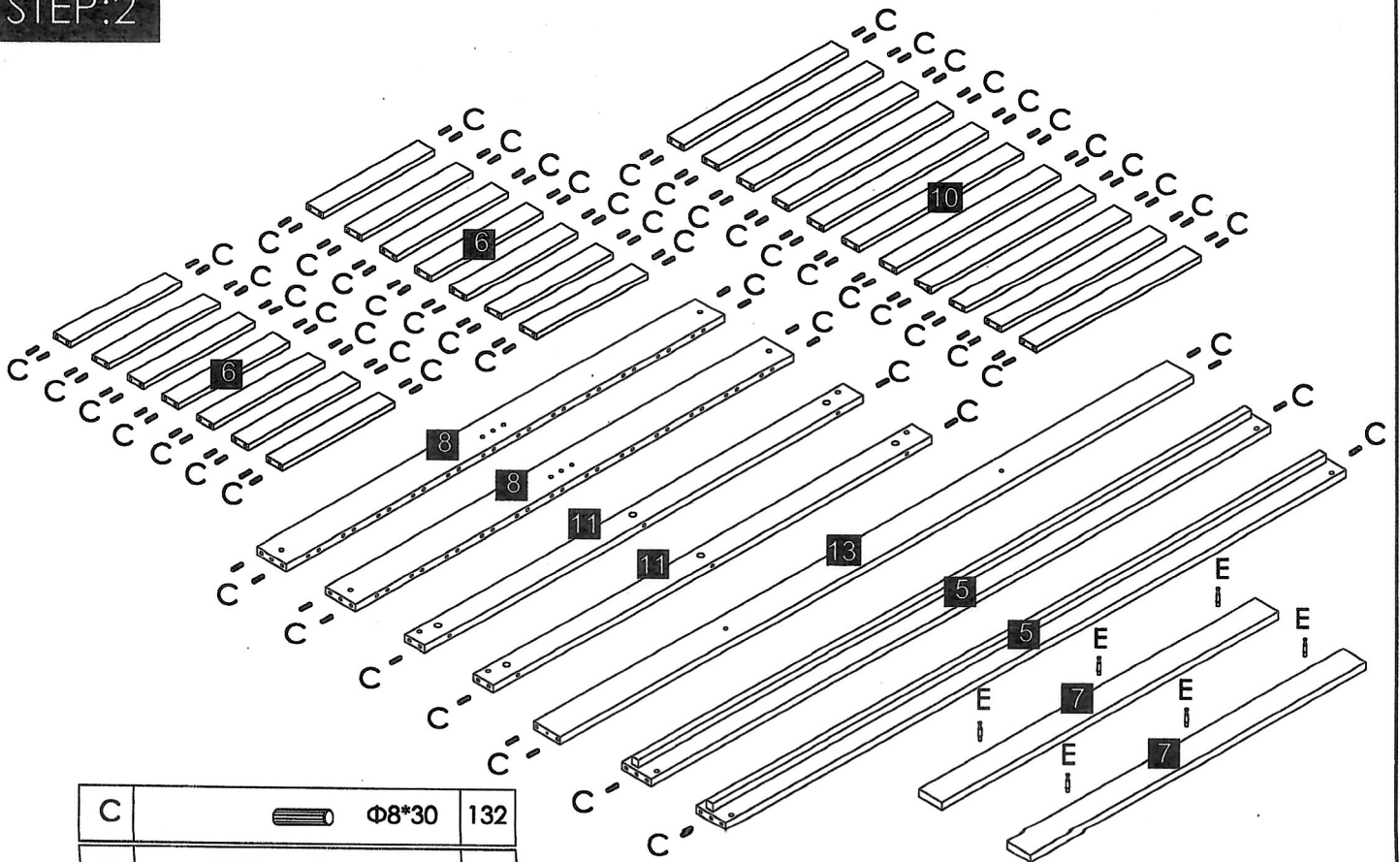

STEP:2



C		Φ8*30	132
E			6

STEP:3

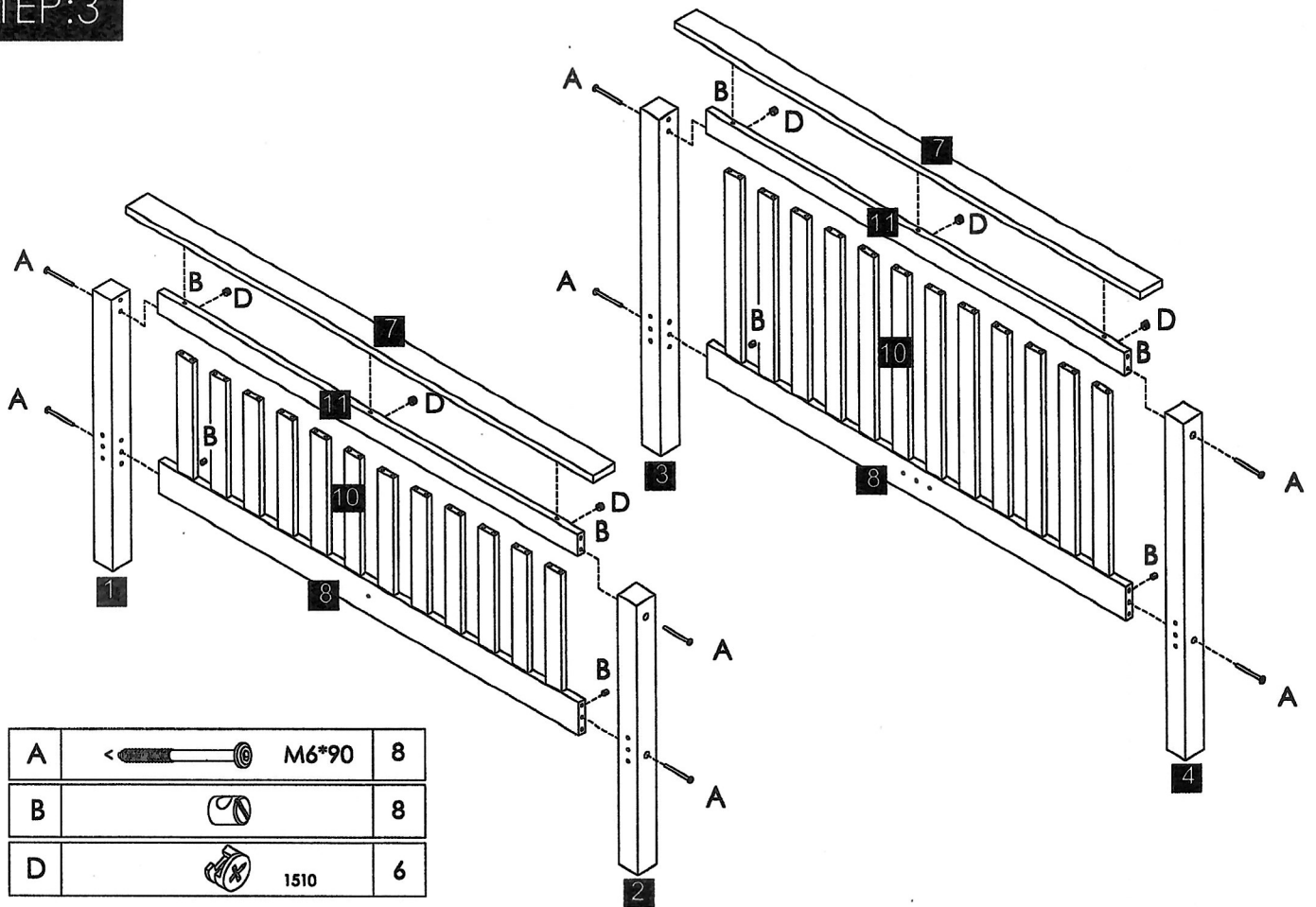

STEP:4

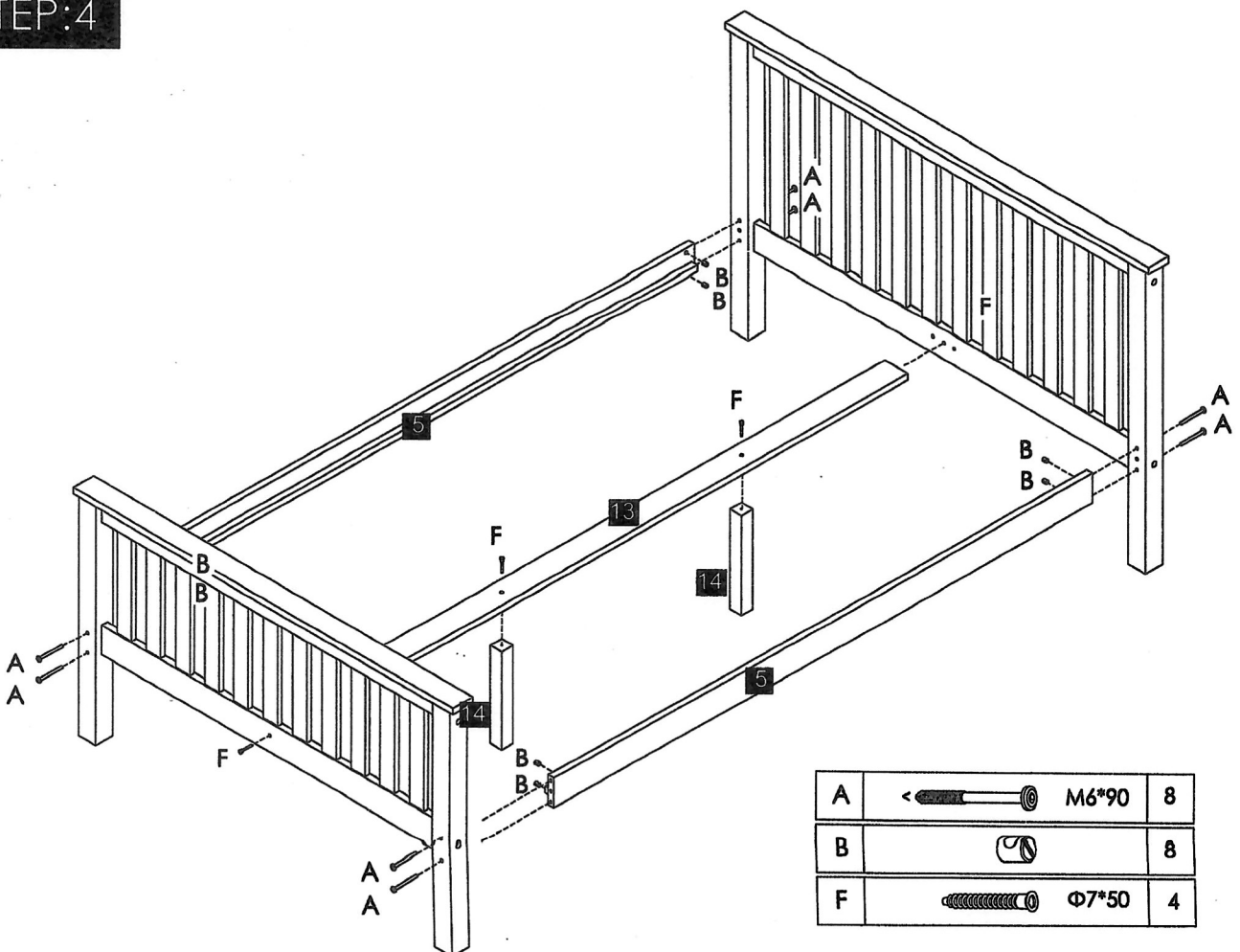

STEP:5

