

# Assembly Instructions

## 4FT6 Lauren Twin & Double Bed

Part in Box 1

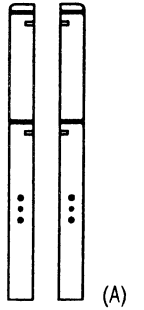

(A) Head Post x 2

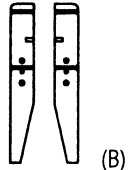

(B) Foot Post x 2

Part in Box 2

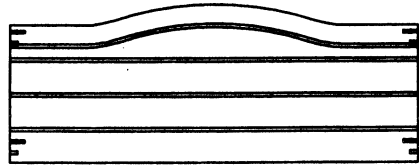

(C) Hb. Panel x 1

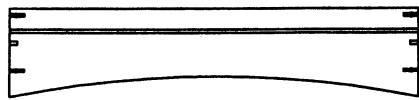

(D) Fb. Panel x 1

Part in Box 3

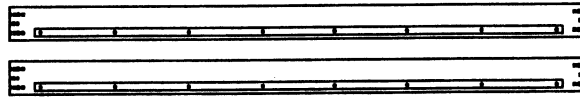

(E) Side Rail x 2

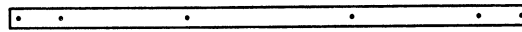

(F) Center Support x 1

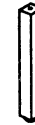

(G)

Support Legs x 4

Part in Box 4

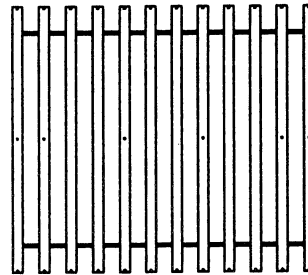

(H) Set of Slats x 1

### Hardware List

1.	JCBC M6 x 70mm		x 8
2.	JCBC M6 x 100mm		x 8
3.	JCBC M6 x 65mm		x 4
4.	JCBC M6 x 45mm		x 2
5.	M4 Allen Key		x 1
6.	M6 x 15mm Barrel Nut		x 8
7.	Wood Dowel M10 x 40mm		x 10
8.	CSK M4 x 25mm		x 24
9.	M6 Hex . Nut		x 2
10.	Flat Washer		x 2
11.	Adjustable Screw		x 4
12.	M6 x 13mm (Short) Barrel Nut		x 8

Tool required for assembly.:

- \* Allen Key ( supplied )
- \* Phillips Screwdriver ( not supplied )

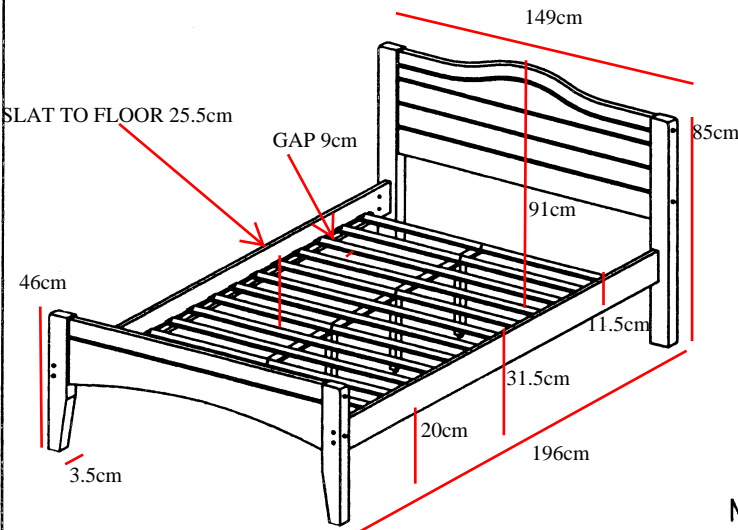

#### ASSEMBLY TIPS

Remove hardware from box and sort by size to check that all hardware and parts are present before assembling. Follow instructions below in the proper sequence to ensure fast, easy and correct assembly.

#### WARNING !!

DO NOT FULLY TIGHTEN ALL BOLTS UNTIL ALL PARTS ARE IN PLACE. FAILURE TO FOLLOW THIS INSTRUCTION MAY CAUSE THE BOLTS TO BE MISALIGNED DURING THE ASSEMBLY.

NOTE : DURING ASSEMBLY , DO NOT TIGHTEN ANY SCREWS UNTIL THE COMPLETE UNIT HAS BEEN ASSEMBLED.



Thank you for purchasing this quality product. Be sure to check all packed material carefully for small parts which may have come loose inside the carton during shipment. Place all parts on a clean , smooth surface such as a rug or carpet to avoid scratching the parts. Be sure you have all the parts and hardware before you begin assembly.

# Assembly Instructions

## Lauren Twin & Double Bed

1

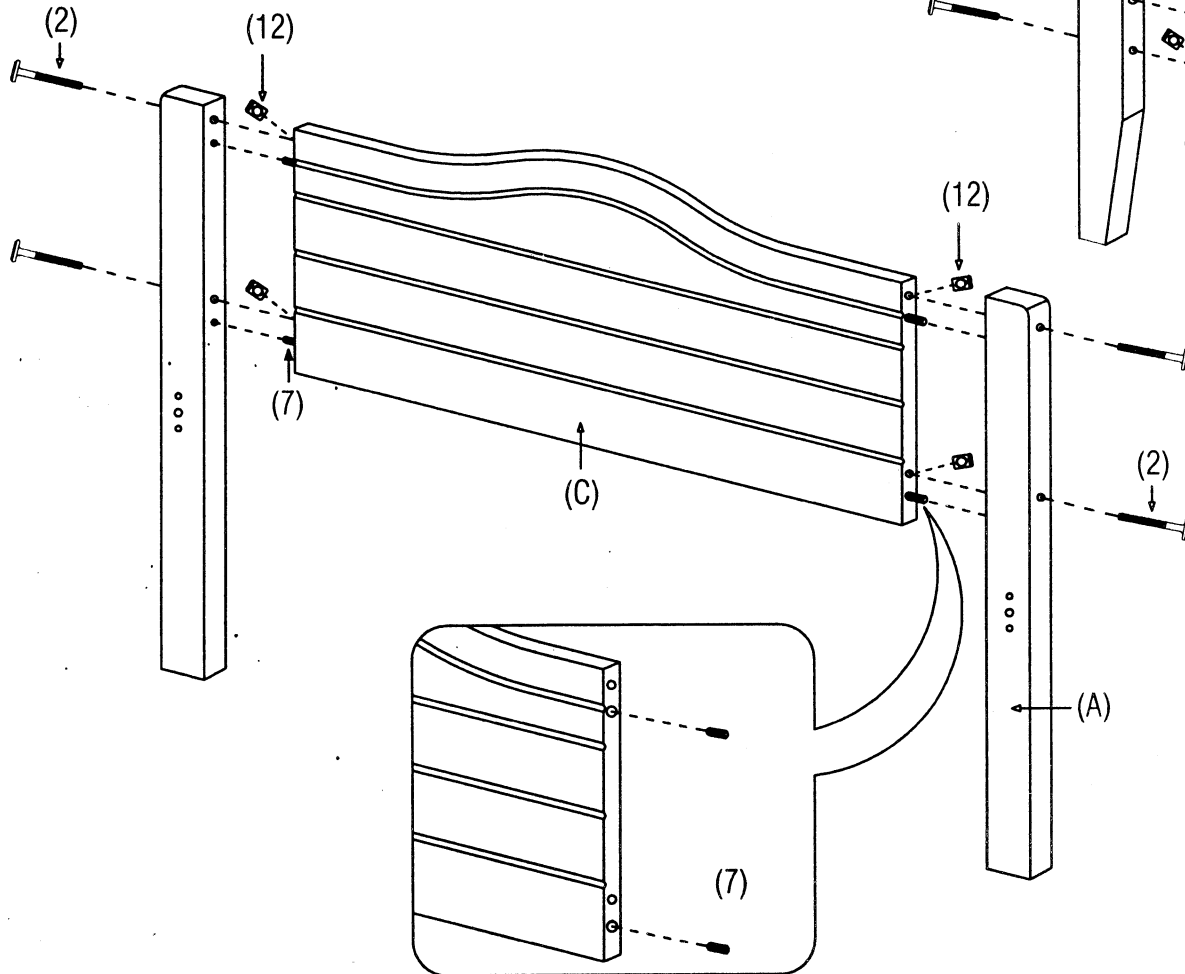

Assemble the Head Post (A) to the Hb. Panel (C).

2.	JCBC M6 x 100mm		x 4
12.	M6 x 13mm (Short) Barrel Nut		x 4
7.	Wood Dowel M10 x 40mm		x 4



2

Assemble the Foot Post (B) to the Fb. Panel (D).

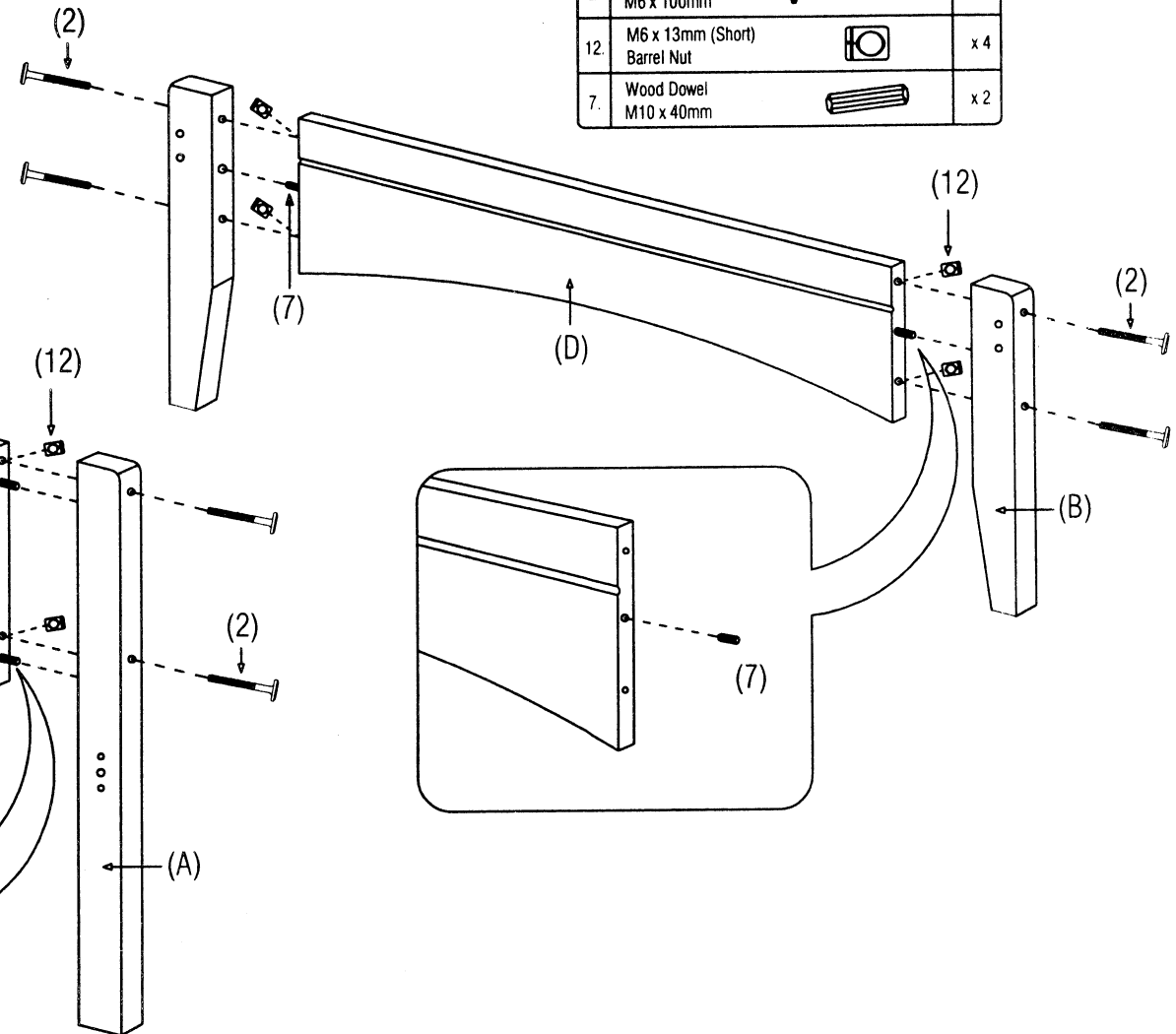

2.	JCBC M6 x 100mm		x 4
12.	M6 x 13mm (Short) Barrel Nut		x 4
7.	Wood Dowel M10 x 40mm		x 2









# Assembly Instructions

## Lauren Twin & Double Bed

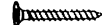
**3** Attach the Side Rails (E) to the Headboard and Footboard.

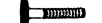
1.	JCBC M6 x 70mm		x 8
6.	M6 x 15mm (Long) Barrel Nut		x 8
7.	Wood Dowel M10 x 40mm		x 4

**4** Lock the Support Legs (G) on Slats (H) & Center Rail (F). Please Note that the Hex Nut or Support Legs (G) have Adjuster at Bottom. Unscrew to Adjust if necessary.  
Assemble the Slats (H) in the place.

8.	CSK M4 x 25mm		x 24
3.	JCBC M6 x 65mm		x 4
4.	JCBC M6 x 45mm		x 2
9.	M6 Hex . Nut		x 2
10.	Flat Washer		x 2
11.	Adjustable Screw		x 4

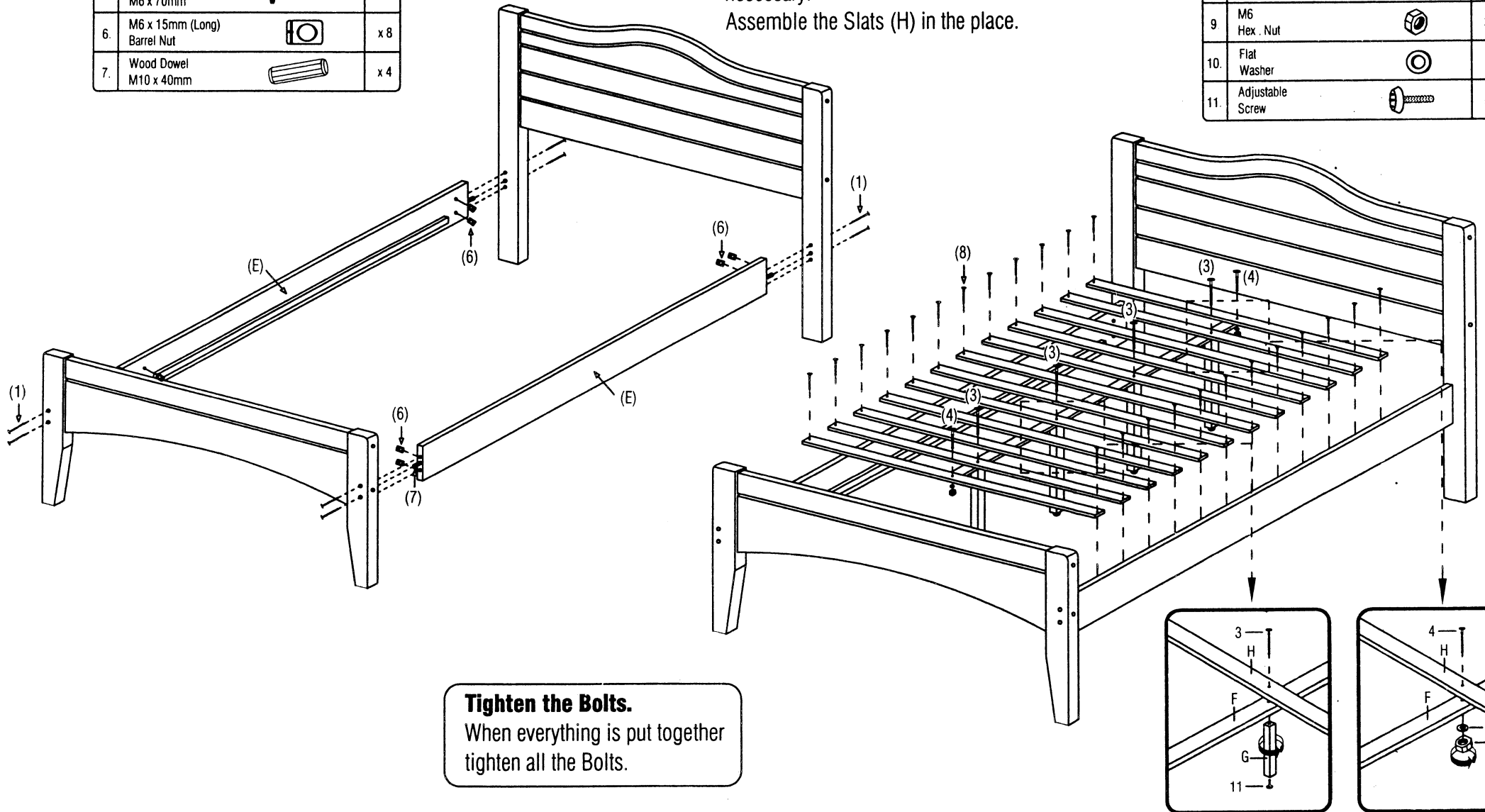

**Tighten the Bolts.**  
When everything is put together  
tighten all the Bolts.